



脈衝式袋濾

集塵機用控制元件

PULES JET TYPE BAG FILTER
CONTROL SYSTEM FOR DUST COLLECTOR



工業污染防治 空氣過濾除塵

MGV系列噴氣脈衝閥



MGV-※※



MGV-※※S



MGV-※※U

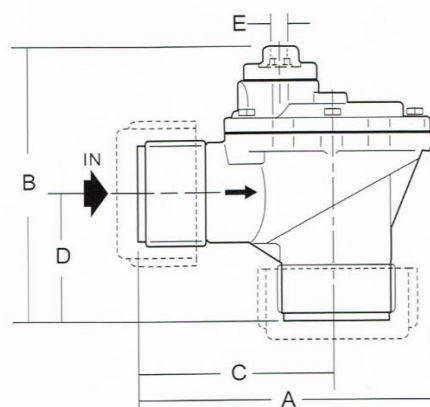
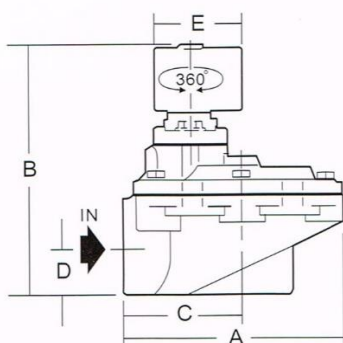
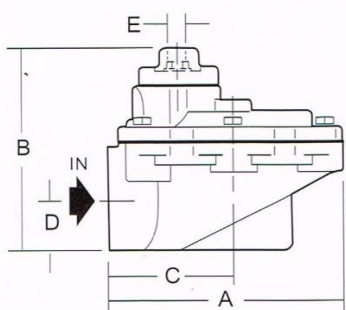

型號 MODEL	管徑(PT) PIPE SIZE	流孔口徑 ORIFICE	C V 值 FACTOR	A	B
MGV-20	3/4"	25	12	90	64
MGV-25	1"	30	25	90	64
MGV-40	1 1/2"	45	52	140	119
MGV-50	2"	57	85	180	157
MGV-65	2 1/2"	68	104	180	157
MGV-80	3"	80	140	215	177
MGV-20S	3/4"	25	12	90	116
MGV-25S	1"	30	25	90	116
MGV-40S	1 1/2"	45	52	140	160
MGV-50S	2"	57	85	180	210
MGV-65S	2 1/2"	68	104	180	210
MGV-80S	3"	80	140	215	230
MGV-25U	1"	30	25	114	116
MGV-40U	1 1/2"	45	52	169	167
MGV-25SU	1"	30	25	114	168
MGV-40SU	1 1/2"	45	52	169	210
不鏽鋼 MGV-39	1 1/2"	45	52	140	119
MGV-39S	1 1/2"	45	52	140	160

PULSE JET VALVE



MGV-※※SU

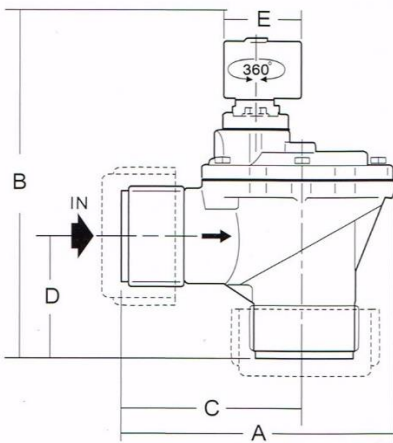

特長:

- 本體全部鋁合金(不鏽鋼)射出一體成型，內部構造阻力小，進出口成90°直角便於安裝，保養簡易。
- 特別選用品質優良之膜片，彈性特佳、耐壓強、不易老化壽命最長。
- 利用絕佳之膜片快速開啓，瞬間脈衝震波，高壓噴射，流量大，逆洗效果最好。
- 使用密閉型防水線圈，動作準確，品質優良，電壓有AC 110V 220V及DC 24V(備有出線型及DIN插頭式供選擇)。

- The pulse valves are especially designed for dust collector service application, combining high flow, long life and extremely fast opening and closing to produce reliable and economical operation.
- The high flow, angle type bodies provide convenience for installation and maintenance,
- The design with integral compression fittings will facilitate installation because there is no need for threaded piping.
- The high quality diaphragms have great elasticity and are wear resistant to guarantee a long operating life.
- The pulse valves have airtightly waterproof coils with high quality and act precisely. There are AC110V, 220V, and DC 24V.

C	D	E	寬 WIDTH	重 量 WEIGHT	膜片型號 DIAPHRAGM NUMBER
52	21	1/8" PT	75	0.45	MGD-25N
52	21	1/8" PT	75	0.41	MGD-25N
72	30	1/8" PT	137	1.22	MGD-40N
95	44	1/4" PT	170	2.92	MGD-65N
95	44	1/4" PT	170	2.62	MGD-65N
119	58	1/4" PT	195	3.75	MGD-80N
52	21	47	75	0.66	MGD-25N
52	21	47	75	0.63	MGD-25N
72	30	47	137	1.40	MGD-40N
95	44	47	170	3.12	MGD-65N
95	44	47	170	2.79	MGD-65N
119	58	47	195	3.97	MGD-80N
77	69	1/8" PT	75	0.86	MGD-25N
100	71	1/8" PT	137	2.12	MGD-40N
77	69	47	75	1.07	MGD-25N
100	71	47	137	2.28	MGD-40N
72	30	1/8" PT	137	2.25	MGD-40
72	30	47	137	2.40	MGD-40N

MGB系列束管接頭 BULKHEAD CONNECTORS

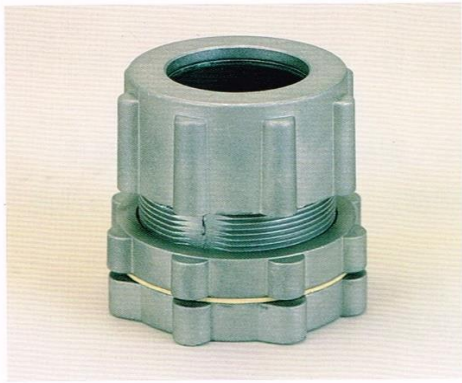

MGB-※※



MGB-※※D

說明：

方便連結脈衝閥與主吹管，省去焊接，以免時間久遠後焊接處腐蝕且造成漏氣的缺點，並可省掉其他配件或攻牙麻煩。

The bulkhead connectors facilitate the installation of pulse valve and blow tube because they eliminate the need for welding. This can avoid defects that the site of welding may corrode or puncture. Also they can simplify matters of threaded pipe connection of using other accessories.

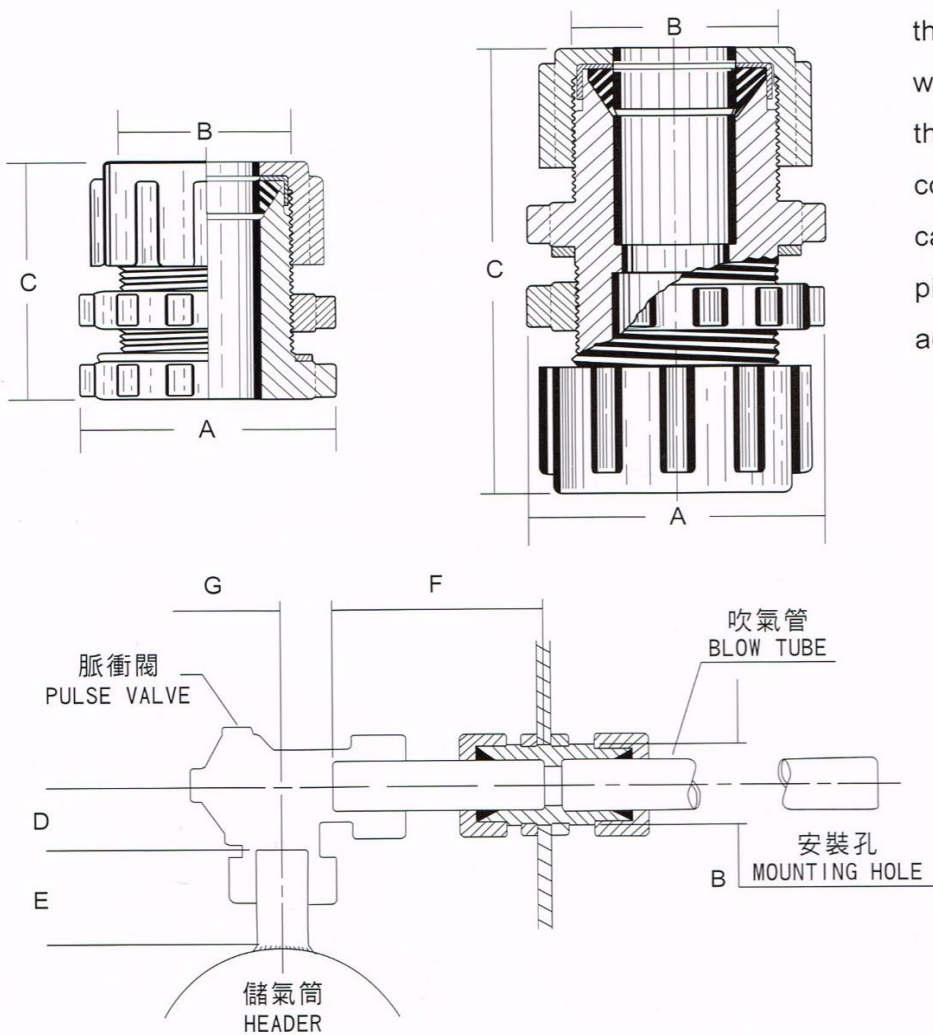

型號 MODEL	管徑 PIPE SIZE	A	B	C	D	E 最小(min)	F 最小(min)	G
MGB-25	1"	78	55	68	39	59	140	31
MGB-40	1 1/2"	97	70	88	60	83	159	31
MGB-25D	1"	78	55	111	39	59	140	31
MGB-40D	1 1/2"	97	70	135	60	83	59	31

MGC系列順序控制器 SEQUENTIAL CONTROLLER

特長

- 採數字顯示，專為脈衝式集塵機設計，在極短時間內完成作動，節省能量，保護濾袋。
- 配線簡單，操作容易。
- ON、OFF時間及STEP數，在範圍內可自由設定。

特別設計

- 啓動開關關閉後可再循環清袋 1 ~ 25 次（自由設定），使關機後可保持濾袋乾淨，以確保濾袋壽命。
- The sequential controllers are specifically designed for pulse jet type dust collector. It can make the action in extremely short time which can save power and protect the bag filter.
- Easy for installation and operation.
- The number of ON、OFF time and STEP can be set up freely in the range.

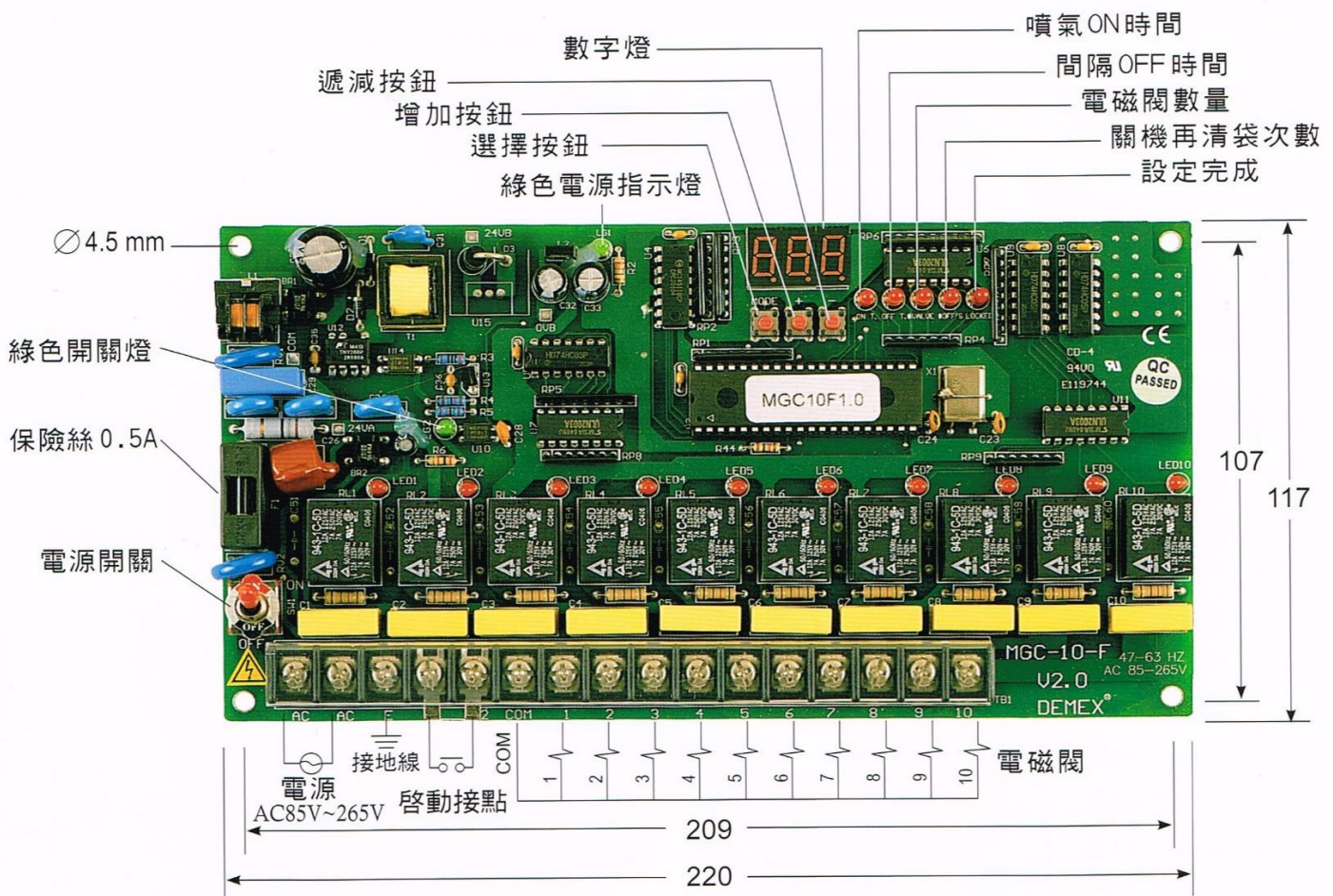

型號 MODEL	電源 POEWR	脈衝時間 ON	間隔時間 OFF	STEP數	關機 再清袋次數	外型尺寸 m/m	固定孔(4.5 ϕ) 距離 m/m
MGC-6S	AC 85V ~ 265 V or DC24V	0.01~9.99S	1~999S	1~6	1~25次	104X170	92X160
MGC-10S				1~10		117X220	107X209
MGC-20S				1~20		173X220	162X209

MGD 系列膜片

DIAPHRAGM

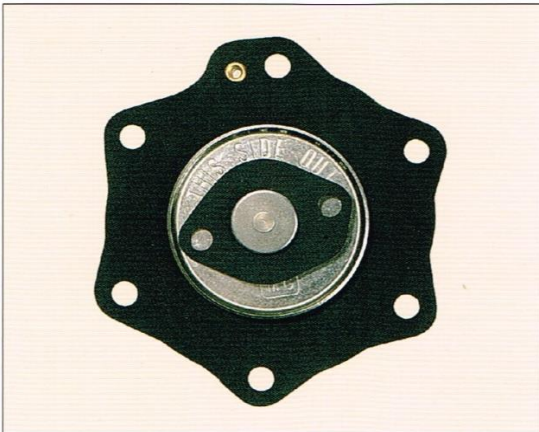

說明：

- 在噴氣脈衝閥之操作中，膜片為其最重要的元件，其性能的優劣，幾乎是脈衝閥品質的代表。
- 本系列所採用的膜片，為進口自歐美的優良製品，非但耐磨性佳、耐壓力強，其良好的彈性，更能準確地與其他控制元件同步執行操作功能，即使在極為惡劣的條件下，亦能保證其正常的使用壽命。
- 本公司同時提供適用各種品牌集塵閥之膜片如規格表(2)，或來樣定作歡迎洽詢。
- In the operation of pulse jet valve, the diaphragm is the most important component. Its function is almost the representation of the quality of a pulse valve.

- The diaphragms that we use here are wear resistant and high pressure resistant. The great elasticity they have can provide a precisely performance of operation with other control element. Even under very harsh conditions, they can still guarantee a normal operation life.
- We supply all kinds of diaphragms for different pulse valve as shown in table 2.

規格表 (1)

型號 MODEL	適用品牌 BRAND	適用脈衝閥型號 CATALOGUE NUMBER	管徑 PIPE SIZE
MGD-25N	"MG"	MGV-20(S), 25(S,U)	3/4"、1"
MGD-40N	"MG"	MGV-40(S,U)	1 1/2"
MGD-65N	"MG"	MGV-50(S), 65(S)	2"、2 1/2"
MGD-80N	"MG"	MGV-80(S)	3"

規格表 (2)

型號 MODEL	適用品牌 BRAND	適用脈衝閥型號 CATALOGUE NUMBER	管徑 PIPE SIZE
MGD-33E	"ASCO"	8353C30 8353C33	3/4"
MGD-35E	"ASCO"	8353C35, R353.41(42), SCG353.52(53, A43, A44) 8353G41, E353.43(44), G353.55(56, A41, A42)	1"
MGD-37EC	"ASCO"	G353A45 G353A66	1 1/2"(單膜片)
MGD-38E	"ASCO"	8353E38, G353A46 R353.46, G353A63	1 1/2"(雙膜片 分離式)
MGD-39E	"ASCO"	8353G39, SCG353A47 R353.47, SCG353A65	1 1/2"(雙膜片 直結式)
MGD-65E	"ASCO"	835348, R353.48, G353.48 835349, R353.49, G353.49	2"、2 1/2"(分離式)
MGD-66E	"ASCO"	8353G50, E353.50, SCG353.50 8353G51, E353.51, SCG353.51	2"、2 1/2"(直結式)
MGD-80E	"ASCO"	E353.58, G353.58	3"(分離式)
MGD-81E	"ASCO"	E353.60, SCG353.60 8353G8	3"(直結式)
MGD-20G	"GOYEN"	CA / RCA 20T	3/4"
MGD-25G	"GOYEN"	CA / RCA 25T (DD,MM)	1"
MGD-35G	"GOYEN"	CA / RCA 35T	1 1/2"(單膜片)
MGD-38G	"GOYEN"	CA / RCA 40T (MM)	1 1/2"(雙膜片)
MGD-40G	"GOYEN"	CA / RCA 45T2 (DD2)	1 1/2"(雙膜片)
MGD-65G	"GOYEN"	CA / RCA 50T, CA / RCA 62T	2"、2 1/2"
MGD-80G	"GOYEN"	CA / RCA 76T, CA / RCA 76MM	3"

MGD系列膜片

DIAPHRAGM

規格表
(3)

型號 MODEL	BRAND	適用脈衝閥型號 CATALOGUE NUMBER	管徑 PIPE SIZE
MGD-19C	"CKD"	PDV-20A / PD-20A	3/4" (第一代)
MGD-20C	"CKD"	PDV2-20A / PD2-20A	3/4" (第二代)
MGD-21C	"CKD"	PDV3-20A / PD3-20A	3/4" (第二代)
MGD-24C	"CKD"	PDV-25A / PD25A	1" (第一代)
MGD-25C	"CKD"	PDV2-25A / PD2-25A	1" (第二代)
MGD-26C	"CKD"	PDV3-25A / PD3-25A	1" (第三代)
MGD-39C	"CKD"	PDV-40A / PD-40A	1 1/2" (第一代)
MGD-40C	"CKD"	PDV2-40A / PD2-40A	1 1/2" (第二代)
MGD-41C	"CKD"	PDV3-40A / PD3-40A	1 1/2" (第三代)
MGD-49C	"CKD"	PDV-50A / PD-50A	2" (第一代)
MGD-50C	"CKD"	PDV2-50A / PD2-50A	2" (第二代)
MGD-25S	"SMC"	VXF2160 / VXFA2160	1"
MGD-40S	"SMC"	VXF2280 / VXFA2280	1 1/2"
MGD-25M	"MECAIR"	VEP / VEM / VNP 208 / 308 / 408	1"
MGD-40M	"MECAIR"	VEP / VEM / VNP 212 / 312 / 412	1 1/2" (單膜片)
MGD-45M	"MECAIR"	VEP / VEM / VNP 214 / 314 / 414	1 1/2" (雙膜片)
MGD-50M	"MECAIR"	VEP / VEM / VNP 216 / 316 / 416	2"

脈衝閥測試表

PULSE VALVE TEST REPORT

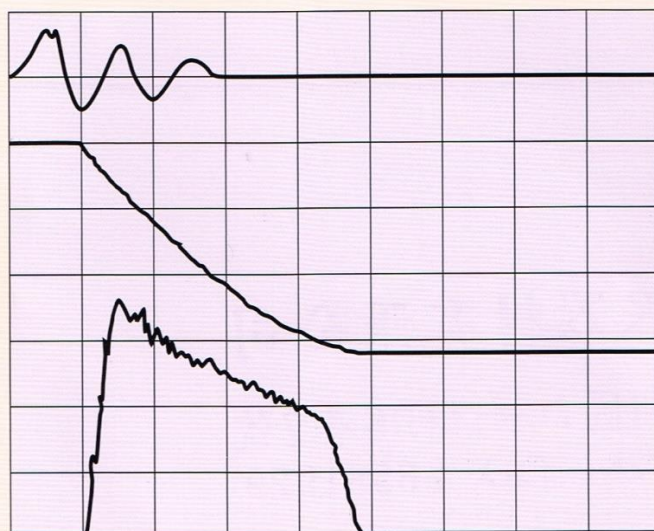

壓力 PEREURE

時間 TIME

型號	: MGV
VALVE TYPE	: 1 1/2"
儲氣筒壓力 Tank pressure	: 6kg/cm ²
通電時間 Electrical pulse length	: 50msec
總脈衝波長 Total pulse length	: 75msec
脈衝最高壓力 Peak pressure	: 3.6kg/cm ²
開閥時間(50%pp) Opening time-to50%pp	: 2.2msec
關閥時間(自50%pp) Closing time-form50%pp	: 25msec
儲氣筒降壓 Pressure drop tank	: 3.2kg/cm ²

FILTERBAG CLEANING

